

Owner's Manual

Audio input cards for the MS-8

MI-1/MI-2/MI-3/MI-4/MI-5

Audio output cards for the MS-8

SO-1/SO-2/SO-3/SO-4/SO-5

<NOTE>

Optional cards should be installed by our authorized service staff. Ask to your installer/dealer or the nearest NetCIRA by Fostex service station.

Example of the MS-8 with the Model MI-2 installed on the front panel.

The MS-8 acts as the master.

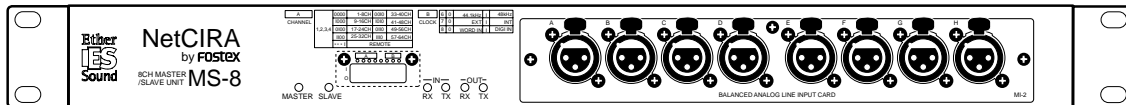

Example of the MS-8 with the Model SO-2 installed on the rear panel.

The MS-8 acts as a slave.

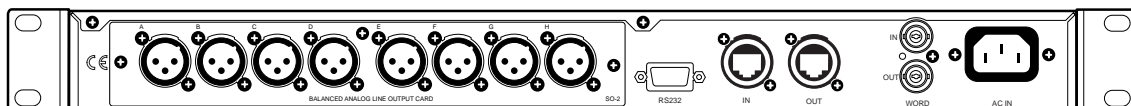

<Note>

Only one input or output card can be installed to the MS-8 either from the front or rear panel.

Optional Card (Inputs)

Model MI-1 (AES/EBU digital input card)

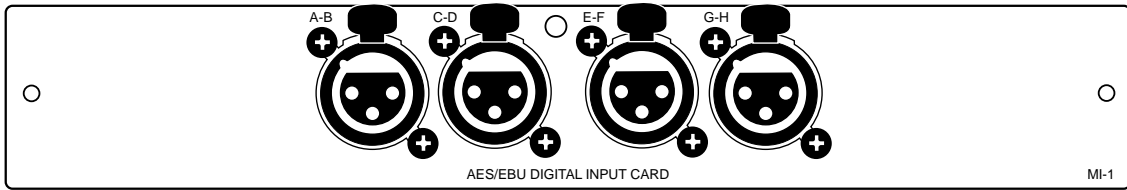

Connector: XLR-3-31 type x 4
 Format: IEC 60958 (AES/EBU)
 Dimensions (mm): 220 (W) x 35.8 (H) x 153 (D)
 Weight: Approx. 160g
 Pin Assignment: Pin1: G / Pin 2: H / Pin 3: C

* Specifications and appearance are subject to change without notice for product improvement.

Model MI-2 (Balanced analog line input card)

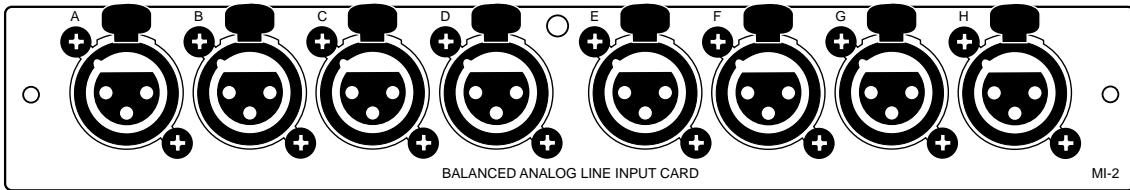

Connector:	XLR-3-31 type x 8	Dynamic range:	115dB or more
Input impedance:	10kΩ or more	T H D:	0.005% or less
Reference input level:	+4dBu (-12dBFS)	Channel separation:	90dB at 1kHz
Maximum input level:	+16dBu	Dimensions (mm):	220 (W) x 35.8 (H) x 153 (D)
Freq. response:	+/-1dB at 20~20kHz	Weight:	Approx. 250g
S/N:	115dB or more	Pin assignment:	Pin1: G / Pin 2: H / Pin 3: C

* Specifications and appearance are subject to change without notice for product improvement.

Model MI-3 (Unbalanced analog line input card)

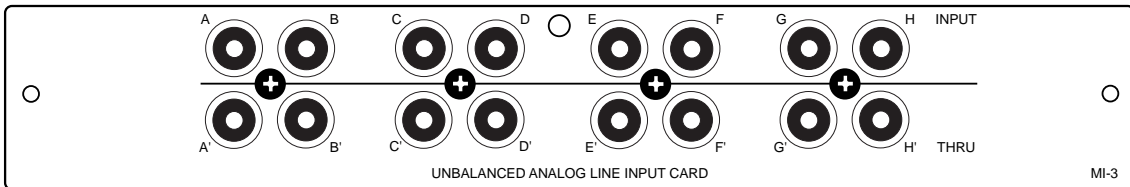

Connector:	RCA pin jack x 16 (IN x 8, THRU x 8)	Dynamic range:	95dB or more
Input impedance:	10kΩ or higher	T H D:	0.01% or less
Reference input level:	-10dBV (-12dBFS)	Channel separation:	90dB at 1kHz
Maximum input level:	+12dBV	Dimensions (mm):	220 (W) x 35.8 (H) x 158 (D)
Freq. response:	+/-1dB at 20~20kHz	Weight:	Approx. 250g
S/N:	95dB or more		

* Specifications and appearance are subject to change without notice for product improvement.

Model MI-4 (ADAT input card)

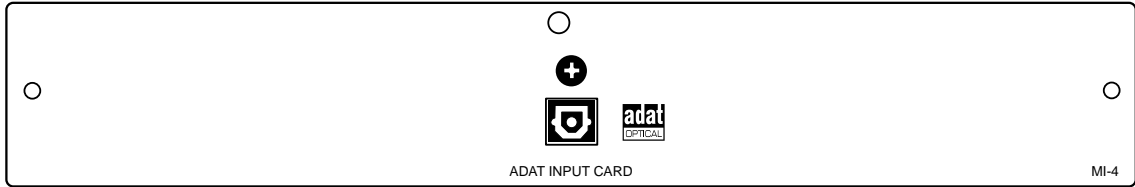

Connector: TOS LINK
 Format: ADAT (Alesis Proprietary Multichannel Optical Digital Interface)
 Dimensions (mm): 220 (W) x 35.8 (H) x 73 (D)
 Weight: Approx. 90g

**"Adat" and the  symbol are trademarks of Alesis Corporation.

* Specifications and appearance are subject to change without notice for product improvement.

Model MI-5 (Balanced analog line input card)

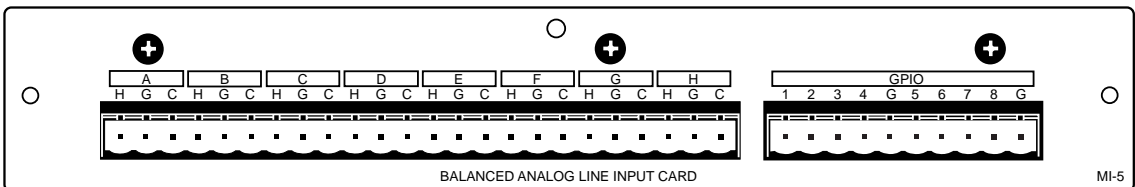

Connector:	Euro 24-pin (analog input)	SN:	115dB or more
	Euro 10-pin (GPIO port)	Dynamic range:	115dB or more
Input impedance:	10kΩ or more	T H D:	0.005% or less
Reference input level:	+4dBu (-12dBFS)	Channel separation:	90dB at 1kHz
Maximum input level:	+16dBu	Dimensions (mm):	220 (W) x 35.8 (H) x 155 (D)
Freq. response:	+/-1dB at 20~20kHz	Weight:	Approx. 250g

* Specifications and appearance are subject to change without notice for product improvement.

* GPIO functions are only accessible through PC software (not supplied) connected to the NetCIRA Primary Master.

* The GPIO pin assignment of the EURO 10-pin connector is as shown below when the unit is shipped. You can change the assignment to fit to your system by changing the short pin positions.

Pin 1 ~ Pin 4 = INPUT, Pin 5 ~ Pin 8 = OUTPUT

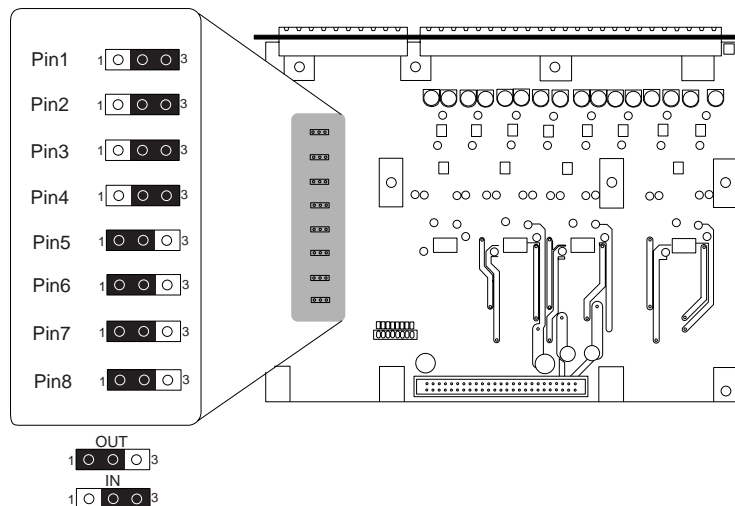

Optional Card (Outputs)

Model SO-1 (AES/EBU digital output card)

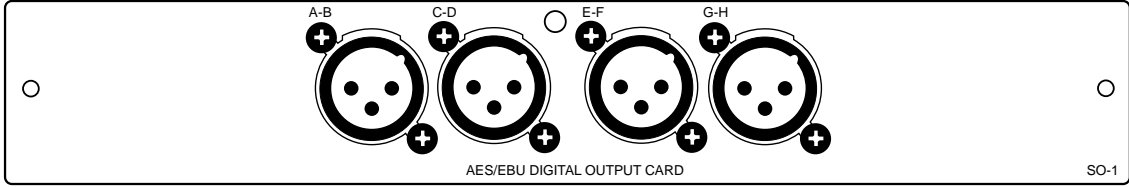

AES/EBU DIGITAL OUTPUT CARD SO-1

Connector: XLR-3-32 type x 4
 Format: IEC 60958 (AES/EBU)
 Dimensions (mm): 220 (W) x 35.8 (H) x 153 (D)
 Weight: Approx. 160g
 Pin assignment: Pin 1: G / Pin 2: H / Pin 3: C

* Specifications and appearance are subject to change without notice for product improvement.

Model SO-2 (Balanced analog line output card)

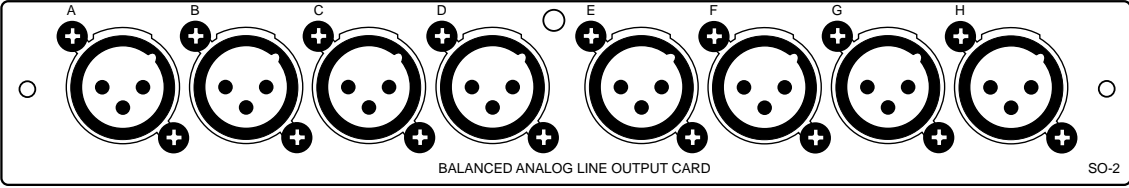

BALANCED ANALOG LINE OUTPUT CARD SO-2

Connector:	XLR-3-32 type x 8	Dynamic range:	115dB or more
Adaptable load impedance:	10kΩ or more	T H D:	0.005% or less
Reference output level:	+4dBu (-12dBFS)	Channel separation:	90dB at 1kHz
Maximum output level:	+16dBu	Dimensions (mm):	220 (W) x 35.8 (H) x 153 (D)
Freq. response:	+/-1dB at 20Hz~20kHz	Weight:	Approx. 250g
S/N:	115dB or more	Pin assignment:	Pin 1: G / Pin 2: H / Pin 3: C

* Specifications and appearance are subject to change without notice for product improvement.

Model SO-3 (Unbalanced analog line output card)

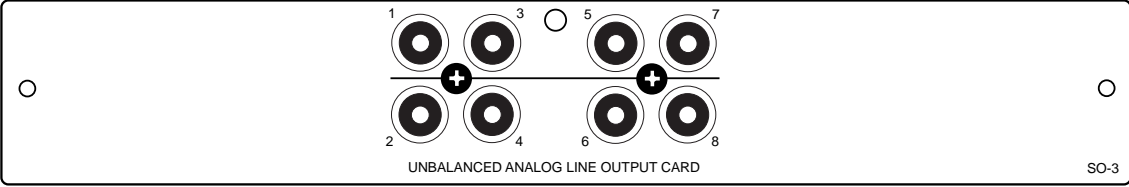

UNBALANCED ANALOG LINE OUTPUT CARD SO-3

Connector:	RCA pin jack x 8	Dynamic range:	100dB or more
Adaptable load impedance:	10kΩ or more	T H D:	0.005% or less
Reference output level:	-10dBV (-12dBFS)	Channel separation:	90dB at 1kHz
Maximum output level:	+2dBV	Dimensions (mm):	220 (W) x 35.8 (H) x 158 (D)
Freq. response:	+/-1dB at 20Hz~20kHz	Weight:	Approx. 140g
S/N:	100dB or more		

* Specifications and appearance are subject to change without notice for product improvement.

Model SO-4 (ADAT output card)

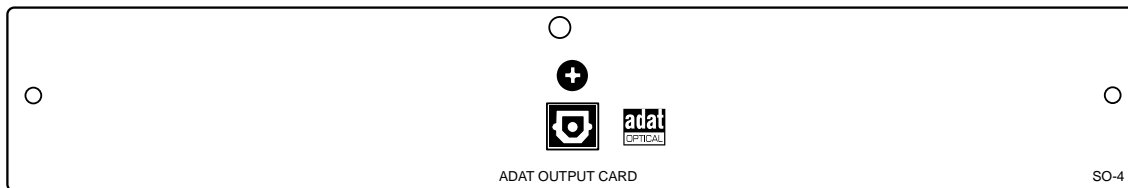

Connector: TOS LINK
 Format: ADAT (Alesis Proprietary Multichannel Optical Digital Interface)
 Dimensions (mm): 220 (W) x 35.8 (H) x 73 (D)
 Weight: Approx. 90g

adat
OPTICAL
 *"Adat" and the OPTICAL symbol are trademarks of Alesis Corporation.
 * Specifications and appearance are subject to change without notice for product improvement.

Model SO-5 (Balanced analog line output card)

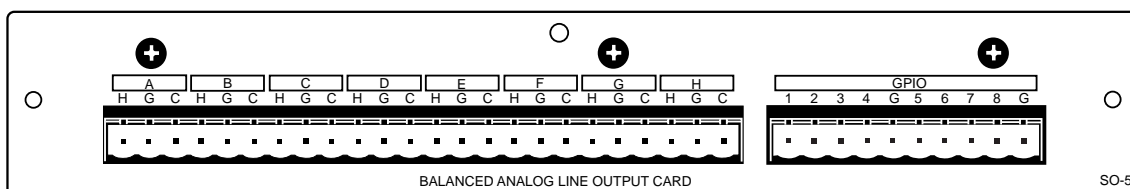

Connector:	Euro 24-pin (analog out)	S/N:	115dB or more
	Euro 10-pin (GPIO port)	Dynamic range:	115dB or more
Adaptable load impedance:	10kΩ or more	T H D:	0.005% or less
Reference output level:	+4dBu (-12dBFS)	Channel separation:	90dB at 1kHz
Maximum output level:	+16dBu	Dimensions (mm):	220 (W) x 35.8 (H) x 155 (D)
Freq. response:	+/-1dB at 20~20kHz	Weight:	Approx. 250g

- * Specifications and appearance are subject to change without notice for product improvement.
- * GPIO functions are only accessible through PC software (not supplied) connected to the NetCIRA Primary Master.
- * The GPIO pin assignment of the EURO 10-pin connector is as shown below when the unit is shipped. You can change the assignment to fit to your system by changing the short pin positions.

Pin 1 ~ Pin 4 = INPUT, Pin 5 ~ Pin 8 = OUTPUT

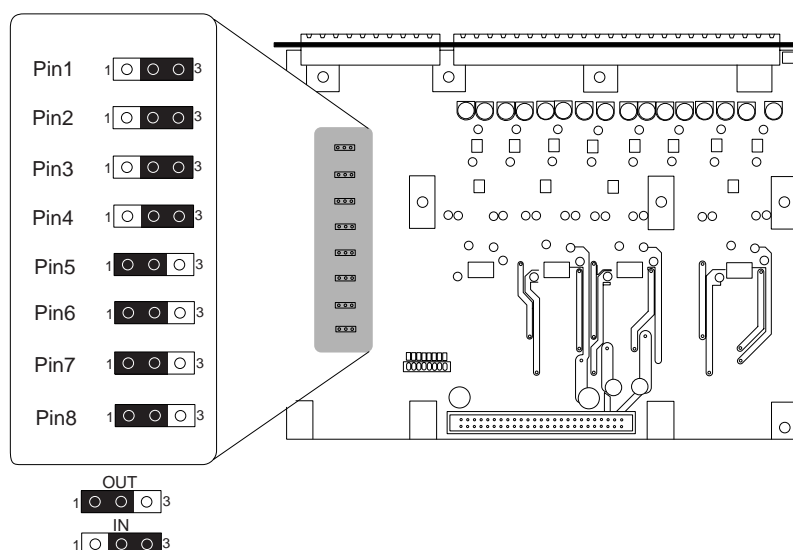

Declaration of EC Directive

This equipment is compatible with the EMC Directive (89/336/EEC) - Directive on approximation of member nation's ordinance concerning the electromagnetic compatibility. This equipment is compatible only when connected to fostex specified product.

The Affect of Immunity on this Equipment

Please comply to the precautions below to make this equipment compatible with European Specification EN61000-6-1 (coexistence of electromagnetic waves - common immunity specification).

NetCIRA
by **FOSTEX**

FOSTEX CO.

3-2-35 Musashino, Akishima-shi, Tokyo, Japan 196-0021